

HT8 MULTI-SPEED DRUM FLOOR SANDER

From Serial Number
08184 (240/240 Volt) & 04804 (110/120 Volt)



OWNERS MANUAL & OPERATING INSTRUCTIONS

CONTENTS

WARNING	1
NORTH AMERICAN SAFETY INSTRUCTIONS	1
MAINS CABLE WIRING - PLUG	1
USE & APPLICATION	1
SPARE PARTS	1
SPECIFICATION	2
SAFETY	2
SET UP	2
PREPARATION	3
OPERATION	3
FLOOR SANDING TECHNIQUE	4
FLOOR TYPES	4
FLOOR SANDING TECNIQUE	5
FLOOR SANDER ABRASIVE GUIDE	6
FLOOR SANDER ABRASIVES	6
SERVICE & ROUTINE MAINTENANCE	7
FAULT FINDING	12
PARTS DIAGRAM	13
PARTS DIAGRAM	14
PARTS LIST	15
CIRCUIT DIAGRAM	16
MULTI-SPEED CABLE ROUTING	16

NORTH AMERICAN SAFETY INSTRUCTIONS



WARNING: This floor sanding machine must be grounded.

This floor-sanding machine shall be grounded while in use to protect the operator from electric shock. The machine is provided with a three-conductor cord and a moulded three-contact grounding type attachment plug to fit the proper grounding type receptacle. The Green (or Green and Yellow) conductor in the cord is the grounding wire. Never connect this wire to any pin other than the grounding pin of the attachment plug.

This floor-sanding machine is provided with an attachment plug as shown in sketch A. It is intended for use on a nominal 120 volt circuit. If a properly grounded receptacle as shown in sketch A is not available, an adaptor as shown in sketch 'C' should be installed as shown in sketch B if the outlet box that houses the receptacle is grounded. Be sure to fasten the grounding tab with a metal faceplate screw.

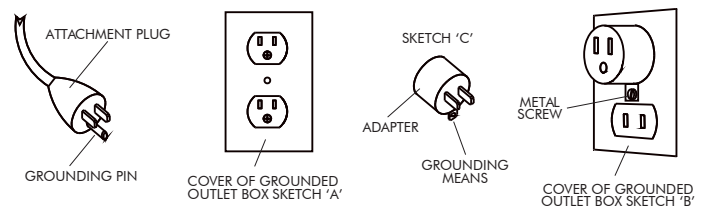

MAINS CABLE WIRING - PLUG

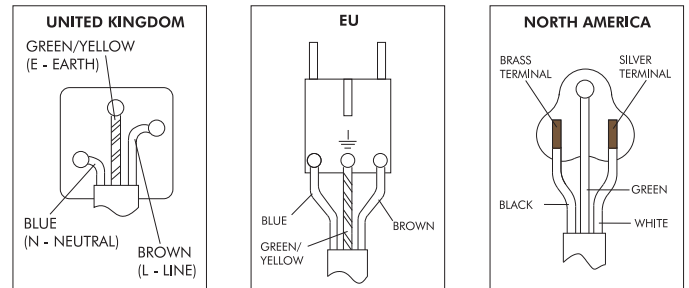

USE & APPLICATION

This machine is intended for commercial use connected with the laying and maintaining of wooden floors and decks.

These types of surfaces may be found both in commercial and household environments.

SPARE PARTS

Use Hiretech genuine spare parts only for service and repair. Use of non-approved parts will void the product warranty. See the back cover of this manual for the terms and conditions of the Hiretech Limited Warranty.

Hiretech reserves the right to make changes or improvements to its products without prior notice.

For the latest product news and updates, spare parts, downloads and service information visit www.hiretech.biz.

WARNING

For safe operation of this machine, read and understand all instructions. Look for the 'warning/caution' symbol.



This symbol means that if you do not follow the instructions injury can occur to the operator and damage to the machine and floor may result.



WARNING: Risk of explosion.

Floor sanding can result in an explosive mixture of fine dust and air. Use this floor-sanding machine only in a well-ventilated area free from any flame, match or source of ignition.



WARNING: Risk of fire.

Never leave the floor sander unattended with dust in the dust bag.



WARNING: Risk of potential injury.

Moving Parts - to reduce the risk of injury, unplug the machine before replacing abrasive sheets or carrying out any form of adjustment or servicing.



SPECIFICATION

The Hiretech HT8 Multi-Speed Drum Floor Sander will sand hard and soft wood floors, cork and composition floors that require rapid sanding and levelling to a fine finish. A powerful motor drives a finely balanced sanding drum which is covered in a unique drum rubber providing a high quality finish to both hard and soft woods and other surfaces. Completely self contained with a high efficiency dust pickup the HT8 breaks down into three simple component parts for easy transport. Multi-Speed control with the choice of four operating speeds, no volt start and overload protection. The HT8 is a high performance floor sander suitable for professional and homeowner use

Power Supply	110/120 V 50/60 Hz 220/240 V 50/60 Hz
Off Load Current	110/120 V 8A 220/250 V 5A
Average Load Current	110/120 V 15A 220/250 V 8A
Noise	95 dBa at 1 metre (3' 3")
Vibration	1.60 m/s ² r.m.s.
Switch	Electronic On/Off switch and multi-speed control with no volt start protection and overload protection.
Motor	Continuous heavy duty AC/DC self cooling 4 brush.
Motor RPM	8,500
Drum RPM	3,300
Sanding Drum	8" (203mm) wide aluminium extrusion with moulded rubber drum cover.
Drive	Non-slip toothed timing belts and gear cut pulleys.
Dust Pickup	Seated oversize vacuum fan with adjustable dust pan, disposable paper dust or cloth bag.
Moving Parts	Sealed for life ball bearings.
Guards	High impact injection moulded ABS.
Abrasive	495mm (19.5") total length x 203mm (8") wide sheet with notched and angled ends 24 to 120 grit.
Power Cable	7m (23') Non-marking outer insulation.
Weight Net	41.5kg (91.5lbs)
Shipping Weight	50.0kg (110.3lbs)
Shipping Dimensions	78 x 40 x 44cm (30.75" x 15.75" x 17.5")
Warranty	2 years

 Read the following Safety and Operational notes before using your Hiretech Floor Sander.

SAFETY

1. For safety it is recommended that a residual current circuit breaker (ground fault interrupter) is used with this machine.
2. Check the operating voltage is correct, the voltage is detailed on the serial plate on the top of the body of the floor sander.
3. Always completely assemble the floor sander and connect the handle cable to the body of the floor sander before connecting to the power supply.
4. Always disconnect from the power supply when changing the abrasive paper, servicing the floor sander, replacing the dust bag or leaving the machine unattended.
5. Always replace the dust bag (paper type) or empty the dust bag (cloth type) when the dust in the bag reaches the 'MAX' line or when the machine is left unattended.
6. Never dispose of or empty the contents of the dust bag into a fire or incinerator.
7. Never reuse the paper dust bag or use a non standard bag. Cloth bags must be in good condition with no holes.
8. Always wear a dust mask when using the floor sander, handling the dust bag or cleaning the machine after use.
9. Wear ear protection when using the floor sander.
10. Ensure adequate ventilation of the work area to avoid the formation of a combustible mixture of flying dust and air.
11. Never smoke when using or servicing the floor sander or when handling the dust bag.
12. Never expose the machine to rain or damp. Always store in a dry place.
13. Stop the floor sander immediately if damage to the machine or abrasive paper is suspected.
14. Never allow the power cable to come into contact with the sanding drum when the floor sander is in operation. If the power cable becomes damaged and the inner conductors are exposed switch the power OFF and remove the plug before attempting to move the machine. The cable must be replaced by an authorised dealer or qualified electrician using Hiretech genuine spare parts only.
15. Keep hands, feet and loose clothing away from all moving parts of the machine.
16. Punch down or remove all nails, screws, tacks and other fixings from the floor before sanding to prevent contact with the sanding drum.
17. Never operate the machine without all the guards in place.
18. Keep children and pets clear at all times.
19. If the machine should fail to operate refer to the Fault Finding Guide on page 12.
20. The HT8 is heavy, take care when lifting and transporting the machine. Always break down the machine into its component parts when lifting and transporting.

SET UP

Assembly and Transport

To help with the following instructions please refer to the parts drawing on page 13 and 14 to identify the component reference (Ref) numbers.

1. The HT8 breaks down into three component parts, the main body, handle assembly and dust tube for easy handling and transport. To assemble loosen the Clamp Bracket Ref.21 and slide the handle assembly into the Handle Bracket Ref.51.

- Adjust the height of the handle so that your arms are slightly bent when standing upright behind the machine. This will provide you with maximum control in operation. Tighten the clamp bracket firmly. Always ensure that the clamp bracket is tight, check periodically during use.
2. Connect the Cable Handle Ref.20 to the Body Twist Lock Ref.24 at the rear right hand side of the floor sander body. Align the plug with the pins, push in and twist clockwise to lock.
 3. Slide the Exhaust Tube Ref.59 into the Exhaust Bracket Ref.56 and push fully home.
 4. Fit a paper dust bag following the instructions printed on the bag. If a cloth bag is used ensure that it is tied securely around the dust tube neck and that the bag is in good condition with no holes.
 5. To prepare the floor sander for use place the machine on the floor and remove the main cable from it's storage position on the handle assembly. Check that the cable is in good condition and that all fittings are secure.
 6. To dismantle the floor sander reverse procedure 1 to 5 above.
 7. Always ensure that the floor sander is secure and cannot move when being transported in a vehicle. The floor sander is heavy. Take care when lifting and carrying the machine. Always break down the machine into its component parts when lifting and transporting.

Installing Abrasive Paper

1. Ensure the power cable is disconnected from the power supply.
2. Tip the floor sander back so that it rests on the handle.
3. Lift the Drum Guard Ref.35 and turn the Drum Ref.168 to expose the Paper Clamp Bar Ref.175. Take care not to trap your fingers when turning the drum.
4. Loosen the 2 Paper Clamp Screws Ref.174 with a coin or suitable screw driver so that the clamp bar raises about 12mm (1/2") only. DO NOT remove the screws completely.
5. Select a suitable grade of abrasive paper (see Abrasive Paper Guide on page 6). To help install course grit abrasive papers draw the smooth side (back) of the paper over the edge of a work bench to make it curl .
6. Kneeling in front of the machine place one end of the abrasive paper under the clamp bar so that the notches align with the clamp bar screws and clamp bar.

Carefully holding the abrasive paper in place rotate the drum 1 revolution. Tuck the other end of the abrasive paper under the clamp bar and use both hands to squeeze the sheet tight around the drum. Make sure it is square to the edges of the drum with no overlap and both ends of the abrasive sheet are equal distance under the paper clamp bar.

Firmly tighten the two clamp bar screws. Check the abrasive sheet is skin tight around the drum. If in doubt repeat the above procedure. Loose or damaged abrasive sheets will tear during sanding and can be expensive to keep replacing. Damage may also occur to the floor and floor sander.

7. Lower the drum guard and stand the machine up. The floor sander is now ready for use.

Note:

Use Hiretech genuine floor sander abrasives for the best sanding performance and finish. They will also reduce the risk of tearing due to poor fit which is a common problem with generic and non standard abrasives.

PREPARATION

1. Where possible remove all furniture from the area or room. The HT8 Drum Floor Sander features an efficient dust pickup, however, some dust will remain on the floor. You can minimise the amount of uncollected dust by using Hiretech disposable paper dust bags and replacing when full.
2. Remove all tacks, staples and other unwanted fixings from the floor. Failure to do so will result in damage to the abrasive paper and sanding drum.
3. Punch all nails below the surface of the floor using a suitable nail punch and hammer. Any screws used to fix boards should be counter sunk below the surface. During sanding any nails or screws that become exposed must be punched or counter sunk further.
4. Firmly fix all loose boards or blocks.
5. Remove heavy wax, grease and dirt deposits by hand.
6. Sweep and vacuum the floor thoroughly to remove dirt and discarded fixings.
7. Ensure good ventilation by opening windows.

OPERATION

1. Move the floor sander to the location of your work.
2. Connect the power cable to a suitable power supply ideally located behind or to one side of the machine and work area.
3. Wear a dust mask and ear protection.
4. Stand close to the back of the floor sander and hold both handles with the main cable held in a small loop in the left hand and then pass the cable over the left shoulder.
5. Apply light downwards pressure on the handles to tip the floor sander back to raise the sanding drum off the floor.
6. To switch on lightly press and hold the ON/OFF button (I/O) until the motor starts (approximately 1.5secs) then release the button.

To switch off lightly press the ON/OFF button (I/O) and the HT8 will switch OFF.

Select one of the four operating speeds by pressing one of the four buttons marked 1, 2, 3 or 4. 1 is the slowest speed, 4 is the fastest speed. See the Multi-Speed Abrasive and Speed Application Chart on page 6 for recommend speeds and applications.

The user may pre-select the operating speed before switching ON.

If the HT8 is switched ON and the motor is running always raise the drum off the floor before selecting or changing the speed.

When the HT8 is disconnected from the power supply the Multi-Speed control will reset to speed position 1 when it is next connected to the power supply.



CAUTION: *the HT8 is a powerful machine. Always ensure that you have a firm grip before switching on.*

6. Now walk slowly forward and at the same time release the pressure on the handles to gently lower the HT8 so that the sanding drum comes into contact with the floor.
7. Guide the floor sander in a straight line at a slow walking pace. Do not force or hold the floor sander back. Allow the machine to do the work and always move at an even pace.
8. At the end of the pass while still moving forward tilt the floor sander back so that the sanding drum comes clear of the floor. Now walking backwards lower the floor sander again

and pull it backwards over the area just sanded moving at a steadily even pace. Take care to ensure that the power cable is kept clear of the sanding drum at all times. At the end of the sanding pass and while still moving backwards tilt the floor sander back so once again the sanding drum comes clear of the floor.

Move the machine over so that it overlaps the area just sanded by approximately 50mm (2") and start to sand the next pass repeating the above technique.

Keep your body/legs close to handle as this will provide better control and make it easier to smoothly raise and lower the drum. If you operate the HT8 with your arms stretched out in front, you will have less control of the floor sander.

 **CAUTION:** to prevent damage to the floor surface, work piece or machine follow these rules.

- i. Always ensure that the floor sander is moving when in operation and the sanding drum is in contact with the floor.
 - ii. Never lift the back of the machine when sanding.
 - iii. Never apply pressure to try to increase the rate of sanding. Damage to the floor and machine will occur.
 - iv. Never bounce or drop the floor sander on to the floor. Always lower the machine gently.
 - v. Never dwell in one place, move steadily at all times.
 - vi. Never allow the power cable to come into contact with the sanding drum.
9. When the dust in the dust bag reaches the 'MAX' line stop sanding. Disconnect the power cable from the power supply and remove the paper dust bag. Turn the top of the paper dust bag over to stop the escape of dust and dispose of into a suitable container. Never reuse the paper dust bag or empty it or dispose of it into a fire. If a cloth bag is used empty into a suitable container being careful to contain the dust. Do not dispose of the contents into a fire.
10. Fit a new paper dust bag or refit the cloth bag. Reconnect the floor sander to the power supply and continue sanding.
11. When taking a break from work disconnect the power cable from the supply, remove and dispose of the paper dust bag, or empty the cloth bag as detailed in 8. above. Never leave the floor sander unattended with the dust bag in place containing dust.
12. On completion disconnect the power cable from the supply. Remove and dispose of the paper dust bag, or empty the cloth bag as detailed in 8. above. Stow the cable on the handle assembly and if required dismantle for transportation. Carry out maintenance as recommended in Maintenance and Servicing.

 **DANGER:** never leave the floor sander unattended with dust in the dust bag. Always remove the dust bag and dispose of into a suitable container.

FLOOR SANDING TECHNIQUE

HT8 Drum Floor Sander - a powerful floor sander designed for the rapid levelling and sanding of all types of wood flooring excluding thin laminated or veneered floors. Load the sander with abrasive making sure that it is skin tight around the drum. Loose sheets will tear. Place the sander on the right hand wall (unless you are making an angled cut on uneven floors) with about two thirds of the floor in front of you. Start the sander with the drum off the floor then walk forward at an even pace and ease the drum on to the

floor. As you near the end of the pass, gradually raise the drum off the floor. Practice this technique before turning on the sander.

Cover the same path you made on the forward cut by pulling the machine backwards and easing the drum to the floor as you begin the backward pass until you reach the original starting point, then ease the drum off the floor.

When two thirds of the floor is sanded, turn the floor sander around and sand the remaining third in the same way. Overlap the one third area by 0.6 to 0.9 meters (2 to 3 feet) with the two thirds area to blend the two areas together.

 **WARNING:** never bounce the sanding drum or dwell in one place as this will sand dips and hollows in the floor.

HT7 Disc Floor Sander (Edger) - a powerful disc floor sander designed for sanding along the edges of a floor without damaging the baseboards or mouldings. Also suitable for smaller areas where the HT8-1.2 Floor Sander will not reach like stair treads and closets load the abrasive disc making sure the retaining bolt is tight. Start the edger with the disc off the floor then lower the disc to the floor as you move the sander. Work progressively moving the sander in a sweeping motion from side to side.

HTF Orbital Floor Sander - a orbital action floor sander designed for re-finishing, sanding between coats of varnish and re-surfacing floors in good condition. Load the abrasive sheet, pad or strip. Start the sander, move immediately and sand in the direction of the grain using the same technique as the drum floor sander. For difficult to reach areas use the disc floor sander with a fine grit abrasive, or sand by hand.

Hand Sanding - to sand difficult to reach areas scrape and sand the floor by hand. Use a scraper to remove old finishes, always scraping in the direction of the grain, and then sand by hand using the same grit abrasive as you finished with when machine sanding. See Floor Sanding Technique diagrams on page 5.

FLOOR TYPES

Plank & Strip Floors

Old floors in good condition - when the floor is in good condition - no uneven edges, cupping or crowning of planks and strips - and you want to re-surface the floor, sanding back to new wood, start sanding in the direction of the planks or strips - with the wood grain. Start with a medium grit abrasive. Complete the first cut with the HT8-1.2 Floor Sander then sand up to the baseboards and door thresholds with the HT7-2 Disc Floor Sander, using a medium grit abrasive, blending the edges in with the main floor area. Sweep the floor. Using a medium/fine grit abrasive, sand the main floor area with the drum sander and then complete the floor with the edger using a fine grit abrasive. Sweep the floor. Finish sanding the main floor area with the drum floor sander using a fine grit abrasive. If the floor is in particularly good condition (level with no deep scratches or blemishes) you may re-surface the floor using the HTF-2 Floor Sander, however, as the sanding action of this machine is less aggressive than the HT8-1.2 Floor Sander the job will take more time.

Uneven floors - when the floor is uneven sand diagonally at 45o across the room in both directions using the HT8-1.2 Floor Sander with a coarse grit abrasive. Only make one cut on both diagonals, this will achieve a basic level. Now complete the floor as for a level strip or plank floor. Use the same grit abrasive as was used on the 45o cut for the first cut parallel to the planks or strips.

Floors with an existing finish - when re-finishing a floor remove as little of the existing surface as possible. If the old finish is worn and the floor is generally in good condition use the HTF-2 Floor Sander with Hiretech abrasive pads and strips which have been especially designed for re-finishing floors. These will maintain the integrity of any stain used to colour the wood and prepare the surface for a new coat of finish. If the floor is badly marked and scratched and has to be sanded back to new wood use the HT8-1.2 Floor Sander and HT7-2 Disc Floor Sander. Always try a medium grit paper first, particularly on a diagonal cut. If 90% of the old finish is removed and the floor is generally level, you do not need to use a coarse grit abrasive.

Engineered and Thin Floors

Use the HTF-2 Floor Sander for engineered or thinner floors that may have been subjected to repeated sanding. The HTF-2 will remove old surface finishes and prepare the floor for re-finishing. Sand the floor using the same method as a strip, plank, or parquet floor. If the floor has deeper scratches or marks these should be sanded out by hand and blended in with the main floor. To check the wood depth in the floor remove a baseboard or moulding from around the edge of the floor. This should provide access to the edge of the floor for inspection.

Parquet & Block Floors

The grain of the wood will run in a number of directions so sand the floor in the direction of the main source of natural light in the room. If there is no source of natural light sand in the direction of the longest side of the room or, if the room is square, in the direction the furniture is laid out and how people normally use and view the room.

This technique will help mask any imperfections in the floor. Complete the sanding operation as detailed for plank or strip floors.

Between Coats of Finish (varnish)

Use the HTF-2 Floor Sander to sand between coats of floor finish, particularly when using water based varnishes. These types of finishes tend to raise the wood grain when first applied to raw wood. Allow each coat of varnish to dry completely following the manufactures directions. Use Hiretech abrasive pads to sand between each coat of varnish. The fine abrasive pads will remove light brush/applicator marks and raised grain while maintaining the integrity of the coat of varnish applied.

FLOOR SANDING TECHNIQUE

Level uneven floors.

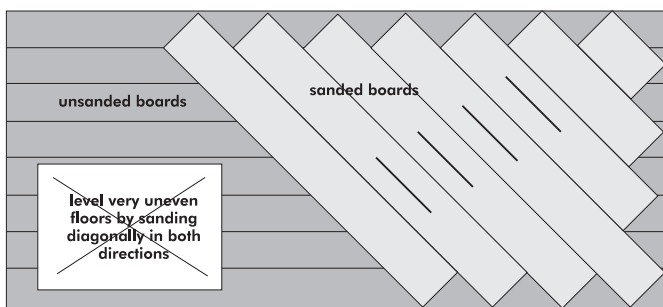

Sand main floor area.

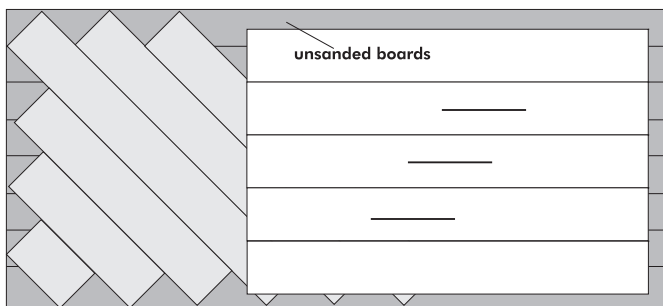

Plank and Strip Floors - sand in the direction the boards are laid wood grain.

Parquet and Wood Block sand in the direction of source of natural light. If there is no natural source of light, sand in the direction of the longest side of the room. If the room is square sand in the direction the furniture is laid out and how people normally use the room.

Sand and blend edges in with main floor area.

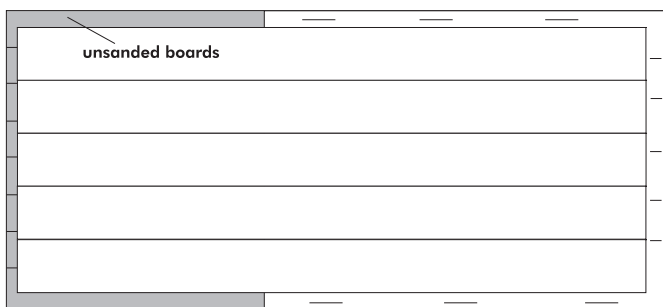

FLOOR SANDER ABRASIVE GUIDE

Abrasive Grade	Floor Type and Condition
Grit P24 Open Coat (Very Coarse non-glogging)	For removing surface coatings from old floors such as varnish, stains and wax polishes. For the rapid sanding and removal of scratches and marks. Sanding level the joints of sub-flooring like particle board and masonite.
Grit P24 (Very Coarse)	For the rapid sanding and removal of scratches and marks. Sanding level the joints of sub-flooring like particle board and masonite.
Grit P36 to P50 (Coarse/Medium)	For removing surface coatings from old floors such as varnish, stains and wax polishes. For the rapid sanding and removal of scratches and light marks. Sanding level the joints of sub-flooring like particle board and masonite.
Grit P60 to P80 (Medium)	For the rapid sanding and removal of scratches and light marks. Sanding level the joints of sub-flooring like particle board and masonite.
Grit P100 to P120 (Medium/Fine)	Intermediate sanding of all types of wood floor. For final sanding of all types of wood floor.
Grit P150 - P180 (Fine/Very Fine)	For final sanding of all types of wood floor. First sanding of cork or composition floors. For sanding between coats of solvent based and 2 pack varnishes.

DO NOT OVER-SAND USE ONLY AS HEAVY GRADE ABRASIVE AS IT TAKES TO DO THE JOB. PROGRESS FROM FIRST GRADE USED THROUGH FOLLOWING GRADES TO REMOVE ALL VISIBLE SANDING MARKS.

DO NOT MISS A GRADE.

FLOOR SANDER ABRASIVES

Hiretech Abrasives	HT8/DU8 FLOOR SANDER SHEET 20 & 50/CASE	HT8 EX FLOOR SANDER BELTS 5/CASE	HT7/SUPER 7 EDGER DISC FIBRE BACKED 25/CASE	HT7/SUPER 7 EDGER DISC PAPER BACKED 25 & 50/CASE	HTF FLOOR SANDER SHEET ADHESIVE BACKED	HTF ABRASIVE PAD 20/CASE
P16	-	-	01025	-	-	-
P24 Grit Open Coat	01001	-	-	01044	-	-
P24 Grit	01002	01010	01026	-	-	-
P36 Grit	-	01011	-	-	-	-
P40 Grit	01003	01012	-	01045	01750	-
P50 Grit	-	01013	01027	-	-	-
P60 Grit	-	01014	-	-	01751	-
P80 Grit	01004	01015	01028	01046	01752	-
P100 Grit	-	01016	-	-	-	-
P120 Grit	01005	01017	01030	01048	01754	-
P150 Grit	-	01018	-	-	-	-
P180 Grit	-	-	-	-	01756	-
P280 Grit/Backing Pad	-	-	-	-	-	01769

SERVICE & ROUTINE MAINTENANCE

CAUTION: maintenance and repairs must be carried out by authorised personnel only. To prevent injury, always remove the power cable from the power supply before undertaking any work on the machine. Do not operate the floor sander unless it is fully assembled and all guards are in place. Use Hiretech genuine spare parts only.

HT8 Multi-Speed Service Indicator Light

1. To help assist in scheduling routine servicing and maintenance the HT8 Multi-Speed has a run time clock built into the Multi-Speed Control Unit. The run time clock records the time the HT8 motor runs and stores the total run time in memory even when the HT8 is disconnected from the power supply.

Two run time intervals of 100hrs or 300hrs can be set by the operator. When the run time interval set is reached the 'green' power connected light flashes 4 times when the HT8 is first connected to the power supply. The light will then remain ON to indicate that power is connected (see illustration below).

The run time can not be reset until the interval set (100hrs or 300hrs) has been reached. The green power connected light will only flash when the power is first connected and the set number of run time hours has been reached. At all other times the green power connected light will come ON without flashing when the power supply is connected.

From new the run time clock is set to indicate 300hrs of run time. When this pre-set time is reached the green power connected light will flash when the power is connected.

HT8 Multi-Speed Switch

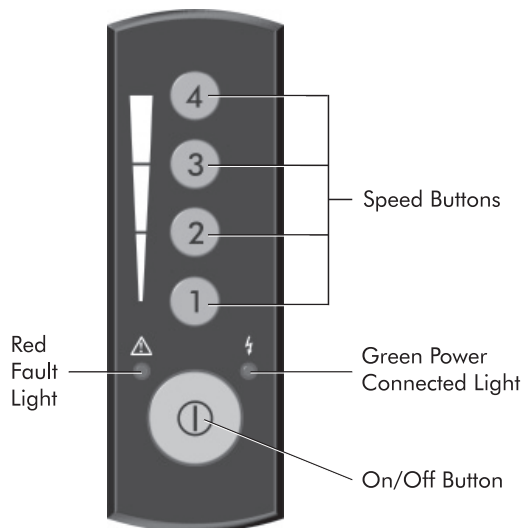

On completion of any service work the run time clock maybe reset to 300hrs or 100hrs at the owners/operators discretion. It is recommend that if the HT8 is owner operated that the run time is reset to 100hrs after the initial 300hr run time until new motor brushes are fitted. When new motor brushes are fitted it is recommended the run time is reset to 300hrs.

If the HT8 is part of a hire or rental fleet it is recommend that the run time is reset to 100hrs at all times to provide for more regular servicing as demanded by the hire and rental market.

CAUTION: the run time indicator is provided as a reminder to the operator/workshop that the HT8 requires a 'full' service paying particular attention to the service areas detailed on the following pages. Routine maintenance should be carried out on a regular basis with special attention paid to guards, cables and general mechanical components.

Note: When a new Multi-Speed Handle Assembly or new Multi-Speed Control unit is fitted carry out a full service including replacing all four motor brushes. This service will then match the initial 300hrs service interval as set from the factory.

2. To reset the run time clock to 300hrs connect the HT8 to the power supply. DO NOT start the HT8. With the power connected and the green power connected light ON, press and hold Speed Buttons 2,3 and 4 together for a minimum of 3 seconds. Speed Button 3 light will flash to indicate that the run time clock has been reset to 300hrs.

Release the Speed Buttons, button 1 will now be ON (yellow light). Disconnect from the power supply, then reconnect to check that the green power connected light does not flash when connecting to the power supply to confirm the reset has been successful.

3. To reset the run time clock to 100hrs connect the HT8 to the power supply. DO NOT start the HT8. With the power connected and the green power connected light ON, press and hold Speed Buttons 1, 2 and 4 together for a minimum of 3 seconds. Speed Button 1 light will flash to indicate that the run time clock has been reset to 100hrs.

Release the Speed Buttons, button 1 will now be ON (yellow light). Disconnect from the power supply, then reconnect to check that the green power connected light does not flash when connecting to the power supply to confirm the reset has been successful.

Note: all four Speed Button lights will turn OFF when a run time reset is started.

4. The run time clock is built into the Speed Control unit and will record the time the HT8 runs. If the handle assembly is used on another HT8 it will record the time that unit runs for. It is recommended that the handle assembly is kept with the same HT8 at all times to accurately record the run time for that HT8.

General

1. Always make a list when first examining the machine, to remind you of parts or action needed on completion of repair/service.
2. The HT8 is subject to high speeds. All screws should be re-fitted using a suitable thread lock compound.
3. On completion of any work or service on an electrical tool or appliance statutory safety tests must be carried out by a competent person and recorded (see Testing for Electrical Safety page 8).
4. The HT8 needs no lubrication during routine servicing.
5. Always ensure that the electrical supply is disconnected before starting any routine servicing or repair.

Visual Inspection

1. Check that the drum guard Ref.35 is in good condition and functioning correctly. Ensure that the Warning Label Ref.36 is present and legible.

2. Check all other guards and mechanical parts are in good condition.
3. Examine the power cable Ref.39 and the handle cable Ref.20. If the outer insulation shows the slightest of abrasions or the inner conductors are exposed, then the cable must be replaced. The cable must not be repaired with tape or insulation sleeve. Note that the Hiretech genuine spare part has a non-marking insulation so that the cable does not mark the floor during use.
4. Examine both the mains plug and the interconnecting socket, Body Twist Lock Ref.24. The plugs must be opened and examined (see Electrical Testing page 8).
5. If a cloth type bag is in service check the condition, old clogged cloth dust bags make for an inefficient dust pickup.
6. Ensure that all labels are present and in good condition.

Drive Belts

1. To examine the condition of the Drive Belts Ref.164 and Ref.165 remove the four screws Ref.83 and the Belt Guard Ref.81.
2. Lift the Fan Belt Ref.165 while rotating the pulley to remove the fan belt. Repeat for the Drum Belt Ref.164.

 **CAUTION:** take care to avoid trapping your fingers when removing or replacing the drive belts.

3. Examine the pulleys for wear, worn or damaged pulleys should be replaced
4. To reduce the instance of belt breakage, examine the drive belts, look for cracks or fraying and replace if necessary with new belts. To replace reverse the above procedure taking care to avoid bending the belts tighter than the pulley diameter as this can result in damaged belts. Refit the belt guard.

Dust Control System

1. For efficient dust pick up ensure that cloth type dust bags are clean and unclogged and that the intake is clear and properly adjusted.
2. Turn the machine on to its side and loosen the three Screws Ref.71 and remove the Dust Shoe Ref.72, check for and clear any obstruction. The grit from the abrasive paper can wear away the leading edge of the dust shoe, if this has occurred then file or grind the leading edge straight before refitting.

Install the dust shoe ensuring that the clearance between the shoe and the drum is maintained at 10mm (3/8").

Lubrication

1. The HT8 is completely lubricated. The bearings are sealed and do not require lubrication. In the unlikely event that a bearing requires replacement use a Hiretech genuine spare part only as the grease contained in these bearings is special. A standard bearing is not suitable and may result in further damage.

Sanding Drum

1. Check that power supply is disconnected. Tilt the machine back and rest the handle on the floor. Open the drum guard and examine the drum cover. A damaged or worn cover must be replaced to maintain machine performance. A damaged or worn cover can result in poor sanding with subsequent damage to the floor surface and can be dangerous in operation. A cover that is worn to 1/4" (6mm) or less in thickness must be replaced.

2. To replace the drum cover see the detailed instructions included in each genuine Hiretech Drum Cover Kit Ref.167 Part # 162312. The use of an impact screwdriver may assist.
3. It is recommended that at each service interval the drum cover is checked and trimmed (dressed) if necessary to provide a true uniform diameter.
4. First check that the rear castors are properly adjusted. Remove the 4 Screws Ref.83 and the Belt Guard Ref.81. Check that the factory mark is present and aligned on the rear castor adjuster Ref.64 and main frame. Adjust as necessary by loosening the two clamp Bolts Ref.65 and adjusting the cam. If the machine has no factory mark on the adjuster and main frame then it is a later type machine that uses a concentric support instead of an adjuster. No adjustment is required.

Note: On earlier models the line stamped on the adjuster and main frame has been set in the factory at the time of manufacture. Never change, deface or alter this line.

5. Fit a sheet of fine grit abrasive paper (120 grit), abrasive side up on to a level floor surface. Remove any abrasive paper from the drum and re-tighten the clamp bar screws. Make sure the clamp bar screws are tight.

Position the floor sander over the abrasive paper and connect the power cable to the power supply. Tip the floor sander back to raise the sanding drum off the floor and switch on.

Gently lower the floor sander so the sanding drum 'just' touches the abrasive paper. Hold the sander in position for a few seconds then tip back and switch off.

Disconnect the power cable and tip the floor sander back so that it rests on it's handle. Lift the drum guard and check the condition of the drum cover. If it is uniform an even surface will be witnessed, if not, continue to dress the drum until all high and low spots are removed. Take care not to remove too much material as this will reduce the life of the drum cover.

6. When a uniform surface is achieved it is advisable to slightly 'feather' both edges of the drum cover. Switch off and disconnect the power cable from the power supply. Tilt the machine back and lift the drum guard to expose the drum cover. Using a medium to fine grit abrasive paper carefully feather the edge of both sides of the drum cover by holding the abrasive paper against the edge and rotating the drum. Be careful not to trap your fingers. The softer edge provided will help prevent 'cut' lines witnessed on the floor surface when sanding particularly in softer woods. Always feather the edges of a new drum cover.

 **WARNING:** the sanding drum and drum cover must be correctly adjusted and maintained to ensure the best sanding performance. Failure to do so can result in damage to the floor surface and can be dangerous.

Care of Motor

1. The motor must be kept free from grease and dust. DO NOT use high pressure air to blow the motor clean. Use a vacuum and soft brush to clean the motor and brush block assembly.
2. The motor brushes must be checked regularly, inspect the brushes every three months or every 300 hours from new and then every 100 hours of use thereafter.

The HT8 Multi-Speed has a run time clock built into the Multi-Speed Control Unit to assist in scheduled servicing. See page 8 for information.

3. Replace ALL FOUR motor brushes when any one brush has worn to 12mm (1/2") or less in length. Brushes MUST slide freely in the brush holders.
4. To inspect and replace motor Brushes Ref.104, with the brush block assembly removed.
 - i. Remove the three Screws Ref.82 and remove the Wall End Guard Ref.84 to expose the motor brush assembly.
 - ii. Remove the four retaining Screws Ref.31 from the Shield Wall End Ref.30, insert two of the screws into the 'jacking holes' situated adjacent to the countersunk retaining holes.
 - iii. Carefully tighten these screws until the shield wall end is jacked clear of the outer casting. Withdraw the shield-wall end.
 - iv. With the brush block assembly complete and the connecting leads still attached. You will note that as the brush block assembly is withdrawn the brushes spring towards the centre and often the brush springs fall clear as the brushes are no longer at a height to retain them. Take care not to lose any springs.
 - v. To remove a brush spring with a brush in the operating position push the brush spring down and towards the brush and lift out.
 - vi. Using a cross recess screwdriver remove the four brush shunt (pigtail) retaining Screws Ref.105 and lock Washers Ref.100.
 - vii. Remove the four brushes. Remove the two 'jacking' screws.
 - viii. Thoroughly clean the brush assembly and housing using a soft brush and a suitable vacuum cleaner.
 - ix. Inspect the four brushes for damage or wear and if any one brush is found to be damaged or worn to a length of 12mm (1/2") or less in length then replace all four brushes.

Motor Brush

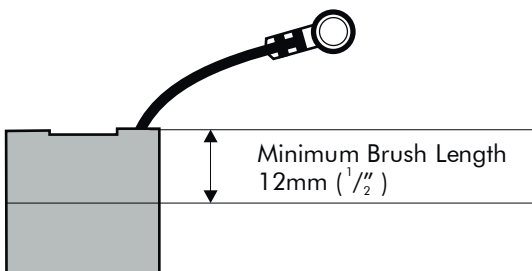

- x. When replacing brushes ensure free movement in each brush holder and fit the brush with the shunt (pigtail) towards the field coil. Ensure that each brush shunt is connected securely with the screw, and lock washer, two spare screws and lock washers are provided with each pack of brushes. Do not fit the brush springs at this stage.
- xi. Pull each brush up to the top of the holder using the shunt wire to retain it in this position for the next stage.
- xii. Enter the assembly into the main frame taking care to avoid contact between the brushes and the commutator of the armature, that the shield wall end is correctly aligned with the main frame and that no leads are trapped. There is a depressed pattern on the shield wall end and on the main frame to assist alignment. Both the bearing fit and the main frame fit are 'light contact' and may require

lightly tapping into position using a soft mallet. DO NOT FORCE.

- xiii. Replace and tighten the four countersunk Screws Ref.31.
- xiv. Remove the four brush block retaining Screws Ref.31 and the single timing Screw Ref.34 from the Shield-Wall End Ref.30. The brush block assembly is now free to rotate. To fit the brush springs rotate the brush block assembly counter clockwise (over towards the rear of the machine) until the lower brush holder is accessible, fit the brush spring by inserting into the holder with the coil spring over the brush then push down until the tag comes into contact with the holder, slide the tag away from the brush and release. The brush spring will clip into position. Check the spring and brush for correct alignment and free movement.
- xv. Rotate the brush block assembly clockwise and repeat to fit the remaining three springs. The switch and field cables restrict the movement of the brush block assembly, take care not to loosen or damage these cables.
- xvi. Return the brush block assembly to its original position and align the timing notch in the block with the timing hole, screw the timing Screw Ref.34 into position.
- xvii. Secure the brush block assembly using the remaining four screws Ref.34. DO NOT OVER TIGHTEN.
- xviii. Finally check that all cables are well clear of moving parts before refitting the guard wall and securing with the 3 Screws Ref.82.

Note: To inspect and replace the motor brushes while retaining the brush block assembly in place repeat the procedure xiv. to xviii. above.

Multi-Speed Control Unit (Switch)



CAUTION: *there are no serviceable components in the HT8 Multi-Speed Control Unit. Under no circumstances must any parts be serviced or tampered with. If the unit fails to operate contact your local reseller. Replacement parts must be fitted by a qualified electrician.*

Fitting a new Switch Multi-Speed (Ref.7)

1. To replace the Switch Multi-Speed Ref.7 remove the four Screws Ref.86 from the Switch Housing Ref.11. Carefully lift the Switch Housing clear of the Handle Tube Ref.16. Take care to avoid damage to the rubber 'O' ring Gasket Switch Housing Ref.10.
The Switch Multi-Speed Ref.7 is connect to the Controller Multi Speed Ref.9 via a ribbon cable. Take care not to stretch or pull this cable.
2. Carefully disconnect the ribbon cable from the Controller Switch Multi-Speed Ref.9 by pushing the two end clips outwards.
3. Remove the six Screws Ref.8 from the Switch Multi-Speed and remove the component from the Switch Housing.
4. Place the new Switch Multi Speed in the Switch Housing and secure using the six Screws Ref.8. Do not over tighten the screws.
5. It is recommended that a new Gasket Switch Housing Ref.10 is fitted. Carefully place the Gasket in the rebate on the back of the Switch Housing.

6. Reconnect the ribbon cable to the Controller Multi-Speed. Ensure that the connection is free of dust, carefully align the ribbon cable plug and push down until the two end clips lock into position.
7. Place the Switch Housing on the Handle Tube taking care not to trap the ribbon cable or dislodge the Gasket Switch Housing.
8. Replace the four Screws Ref.86.
9. Carry out electrical and function tests (see page 13 Electrical Testing).

Fitting a new Controller Multi-Speed (Ref.8)

Note: Refer to the Circuit Diagram on page 19.

1. To replace the Controller Multi-Speed Ref.9 remove the four Screws Ref.86 from the Cover Switch Ref.11. Carefully lift the Cover Switch clear of the Tube Handle Ref.16. Take care to avoid damage to the rubber 'O' ring Gasket Ref.10 The Switch Multi-Speed Ref.7 is connected to the Controller Multi-Speed via a ribbon cable. Take care not to stretch or pull on this cable.
2. Carefully disconnect the ribbon cable from the Controller Ref.9 by pushing outwards on the two end clips positioned each side of the ribbon cable socket. Place the Cover Switch Assembly to one side.
3. Disconnect the Cable Main Ref.39 and remove it together with the Strain Relief Ref. 5 Release the Cable Handle Strain Relief Ref.18 and remove the Earth (Ground) Terminal from the Cable Handle termination at the top of the Tube Handle Ref.16).
4. Remove the 6 Screws and Washers Ref.12 from the back of the Tube Handle to release the Controller Ref.9 You will note that the controller appears to be 'stuck' into position, this is due to the 'Heat Sink Compound used to ensure good thermal contact between the two components. Carefully lever the two components apart taking care not to damage the Tube Handle Ref.16.
5. Disconnect the Cable Handle to Motor Output Terminals and remove the controller.
6. Thoroughly clean the inside of the Tube Handle Ref.16 ensuring the all traces of the old Heat Sink Compound are removed.
7. Carefully apply a thin layer of Heat Sink Compound Ref.13 to the back of the new Controller. Take care to ensure only a very thin layer is applied evenly over the entire rear surface, do not over apply.
8. Connect the Cable Handle to Motor Output Terminals and position the two AC cables alongside the controller so that they will be available for connection later. (see diagram on page 19).
9. Carefully place the new controller into position taking care to line up the 6 mounting holes with the holes in the Tube Handle, secure it into position with the 6 Screws and Washers Ref.12.
10. Carefully following the Diagrams reconnect the Cable Main and the Earth (Ground) Terminal from the Cable Handle, taking care to correctly fit the two Strain Relief's Refs. 5 and 18 to ensure that the cables are properly secured.
11. Examine the Cover Switch Assembly, if the 'O' ring Gasket Ref.10 is damaged in any way replace it by carefully placing the new gasket into position in the groove provided on the underside of the Cover Switch Ref.11 You may find that using a little adhesive such as 'super glue' will help hold the gasket into position during re-assembly.

12. Reconnect the Switch ribbon cable to the controller by pushing it into position and noting that the two clips positioned at each side of the socket lock inwards securing the ribbon cable plug.
13. Place the Cover Switch Assembly onto the Tube Handle and line up the four mounting holes, taking care to avoid trapping any leads or dislodging the Gasket. Secure it into position with the 4 screws Ref.86
14. Carry out electrical and function tests (see Electrical Testing on page 13).

Electrical Testing



CAUTION: testing for electrical safety should be undertaken by a competent person and all results recorded. Do not exceed 1250 volt insulation test duration of 3 seconds.

1. Examine the power cable and handle cable for damage, if the outer insulation shows more than the slightest of abrasions or the inner conductors are exposed then the cable must be replaced. The cables must not be repaired with tape or insulation sleeve.
2. Open and check mains plug and interconnecting socket Ref.24 for condition, loose connections, damaged wires etc. Ensure that the strain relief of the power cable plug is correctly secured to the outer cable insulation.
3. Open and examine the Switch Housing Ref.11 for loose connections, damaged wires, and general condition. Pay special attention to any gaskets, 'O' rings and seals intended to exclude dust from the switch and switch housing area, these must be maintained in good condition. Examine the soft key pad that is located in the switch cover, ensure this is in good condition and the surface is not punctured or damaged.
4. Ensure that the Strain Relief Ref.5 is correctly secured to the outer cable insulation.
5. For the HT8 fitted with a Multi-Speed Control and HT8's fitted with a low volt circuit breaker type switch use a trailing test cable (see part information below) that connects the testing equipment directly to the machine body Base Twist Lock Ref.23 This allows the body of the HT8 to be tested separately from the handle assembly.

Part No. 024500 Test Lead

(use for all regions excluding Australia and North America)

Part No. 024501 Test Lead

(use for Australia)

Part No.:024502 Test Lead (NA)

(use for North America only)



CAUTION: the HT8 Test Lead does not have the LIVE (HOT) conductor connected. Only the NEUTRAL and EARTH are connected at the plug end and the NEUTRAL AND EARTH connected at the Body Twist Lock end. There is also a shunt fitted in the body twist lock to short the LIVE and NEUTRAL terminals to allow a full dielectric test. THIS TRAILING TEST LEAD CANNOT BE USED FOR FUNCTIONAL TESTING.

6. Replace the switch cover taking care to avoid trapping leads and ensuring that the dust gasket is correctly positioned.
7. Place the handle assembly on the test bench then using standard procedure test for electrical safety (CLASS 1 EARTHED APPLIANCE)

DO NOT EXCEED 1250 VOLT FLASH DURATION 3 SECONDS.

RECORD THE TEST RESULTS.

8. Now Place the machine body safely on the test bench and connect the Test Lead to the Base Twist Lock Ref.23 and connect the other end to the test equipment. Then using standard procedure test for electrical safety.(CLASS 1 EARTHED APPLIANCE)

DO NOT EXCEED 1250 VOLT FLASH DURATION 3 SECONDS.

RECORD THE TEST RESULTS.

9. You have now tested both the handle assembly and the machine body, if both show good test results then you can carry out a functional or run test if required by placing the complete machine in a secure position and switching the machine on.



CAUTION: *when undertaking a functional test ensure that the machine is secure, remember the sanding drum will rotate, ensure that the drum cannot come into contact with the work bench/service area.*

10. Ensure that the switch trips to 'OFF' when the current is interrupted. During complete machine functional test with the machine switched on and running. Switch off the electrical supply at the supply socket then when the machine has stopped - switch it back on at the socket. Note that the machine has tripped to OFF and the speed button one (1) is illuminated. You must now press and hold the ON/OFF (I/O) button for 1.5secs to turn the machine ON. If this function fails to operate do not use the machine. Report/repair fault and retest.
-

FAULT	CAUSE	ACTION														
<p>The machine does not run.</p>	<p>The power cable is not connected to the power supply.</p> <p>The overload protection has been activated.</p> <p>The motor brushes are worn.</p> <p>The voltage is too low.</p>	<p>Connect the power cable to the power supply.</p> <p>Allow to cool, switch on.</p> <p>Replace the motor brushes.</p> <p>Check main power supply complies with the machine serial plate data.</p>														
<p>The overload protection activates frequently.</p> <table border="1" data-bbox="145 651 568 1095"> <thead> <tr> <th colspan="2" data-bbox="156 667 558 728">MULTI-SPEED FAULT INDICATOR LIGHT STATUS</th> </tr> <tr> <th data-bbox="156 745 277 775">Condition</th> <th data-bbox="464 745 558 775">Flashes</th> </tr> </thead> <tbody> <tr> <td data-bbox="156 786 272 815">Overload</td> <td data-bbox="523 786 544 815">1</td> </tr> <tr> <td data-bbox="156 824 379 853">Over Temperature</td> <td data-bbox="523 824 544 853">2</td> </tr> <tr> <td data-bbox="156 862 336 891">Under Voltage</td> <td data-bbox="523 862 544 891">3</td> </tr> <tr> <td data-bbox="156 900 392 929">Ribbon Cable Fault</td> <td data-bbox="523 900 544 929">4</td> </tr> <tr> <td data-bbox="156 938 544 967">Frequency Fault (110/120V only)</td> <td data-bbox="523 938 544 967">5</td> </tr> </tbody> </table> <p>The red fault indicator light will flash approximately 40 times per minute in groups of 1 to 5 flashes as detailed above to provide diagnostic information.</p>	MULTI-SPEED FAULT INDICATOR LIGHT STATUS		Condition	Flashes	Overload	1	Over Temperature	2	Under Voltage	3	Ribbon Cable Fault	4	Frequency Fault (110/120V only)	5	<p>The drum motor is stopped.</p> <p>A bearing has failed.</p> <p>The voltage is too low.</p> <p>The pressure on the sanding drum is too high.</p> <p>The sanding drum will not rotate.</p>	<p>Contact an authorised repair agent.</p> <p>Contact an authorised repair agent.</p> <p>Check the main power supply complies with the machine's serial plate data.</p> <p>Fit a finer grit abrasive paper, make sure the voltage is correct.</p> <p>Disconnect from the power and check the sanding drum for obstruction. If overload still operates contact an authorised repair agent.</p>
MULTI-SPEED FAULT INDICATOR LIGHT STATUS																
Condition	Flashes															
Overload	1															
Over Temperature	2															
Under Voltage	3															
Ribbon Cable Fault	4															
Frequency Fault (110/120V only)	5															
<p>The machine will not pick-up dust.</p>	<p>The dust bag is full.</p> <p>The dust shoe is out of adjustment.</p> <p>There is an obstruction in dust pickup.</p> <p>The fan belt has broken.</p>	<p>Replace the dust bag.</p> <p>Adjust the dust shoe.</p> <p>Remove the dust shoe and check for obstruction. Clear as necessary.</p> <p>Replace the fan belt.</p>														
<p>The machine does not sand evenly.</p>	<p>The drum cover is not round.</p> <p>The Floor Roller assembly (adjustable type) is out of adjustment.</p> <p>The Floor Roller assembly is worn or damaged.</p>	<p>Redress or replace the drum cover.</p> <p>Adjust the Floor Roller assembly see page 11.4</p> <p>Repair/replace the Floor Roller Assembly.</p>														
<p>The sanding drum will not rotate.</p>	<p>The machine is not being operated properly.</p> <p>The drum belt is broken.</p> <p>The drum bearing has failed.</p> <p>The shear pin Ref.144 has operated.</p> <p>There is an obstruction.</p>	<p>Read 'Operation' section of this manual.</p> <p>Replace the drum belt.</p> <p>Contact an authorised repair agent.</p> <p>Contact an authorised repair agent.</p> <p>Disconnect from power supply and clear the obstruction.</p>														

PARTS DIAGRAM

HT8-1.2 Clamp Bar Multi-Speed

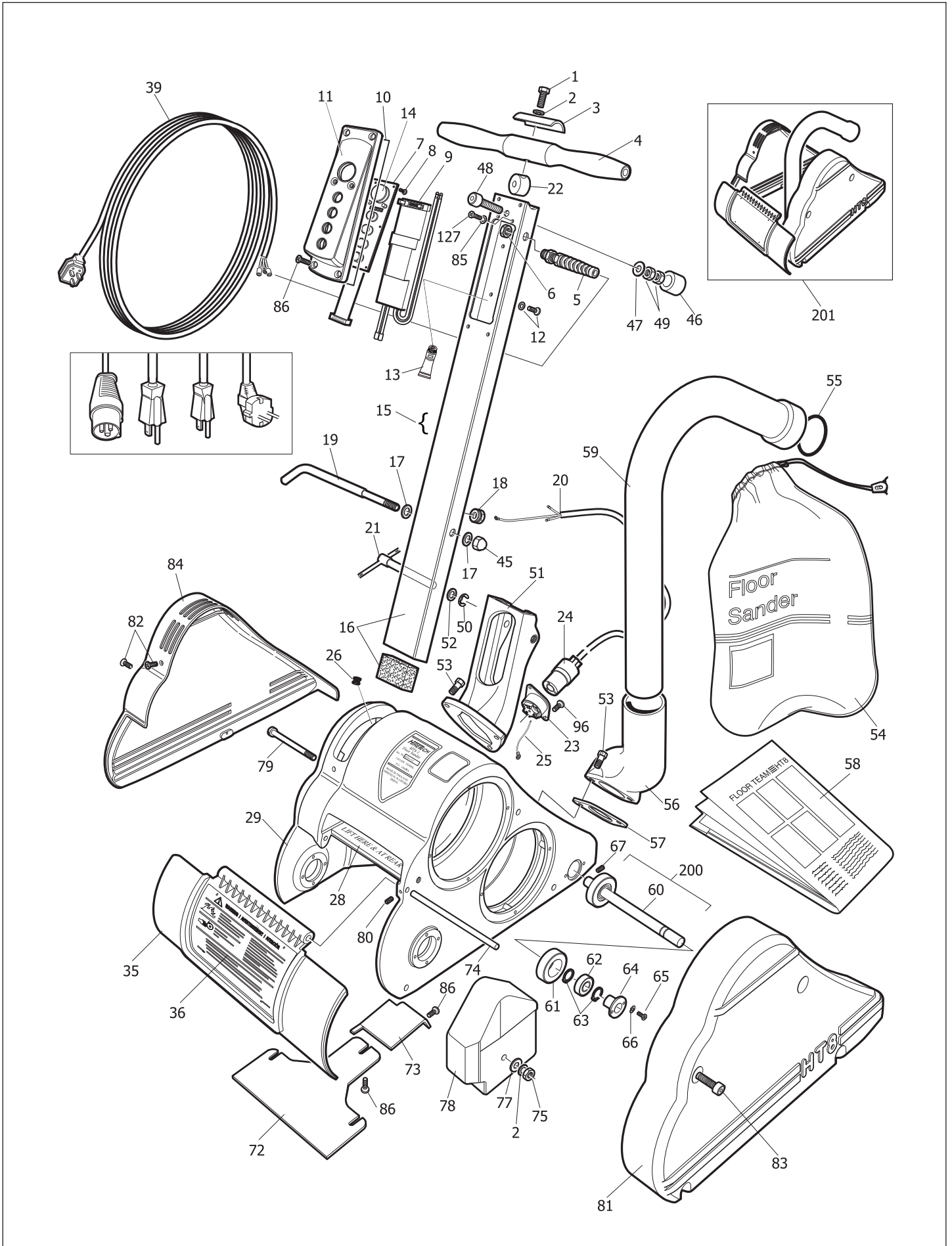

PARTS LIST

Ref PSTK Pack Qty Description

001	962308	1	Screw
002	980652	2	Washer
003	162019	1	Clamp Handle
004	163907	1	Handle Cross
005	101205	1	Strain Relief
005	163691	1	Strain Relief (NA)
006	101206	1	Nut Lock
007	024520	1	Switch Multi-Speed
008	024615	6	Screw
009	024525	1	Controller Switch Multi-Speed 240V
009	024530	1	Controller Switch Multi-Speed 110V
010	163870	1	Gasket Switch Housing
011	024510	1	Cover Switch Multi-Speed
012	024620	6	Screw and Washer Set
013	007633	1	Heat Sink Compound
014	024515	1	Key Pad Switch
015	020300	1	Multi-Speed Conversion Kit HT8/DU8 240V (UK)
015	020305	1	Multi-Speed Conversion Kit HT8/DU8 110V (UK)
015	020310	1	Multi-Speed Conversion Kit HT8/DU8 220V (EUR)
015	020315	1	Multi-Speed Conversion Kit HT8/DU8 240V (AUS)
015	020320	1	Multi-Speed Conversion Kit HT8/DU8 110V (NA)
016	169015	1	Tube Handle Multi-Speed
017	980615	2	Washer
018	101220	1	Strain Relief Handle Cable
018	163804	1	Strain Relief Handle Cable (NA)
019	164508	1	Hook Cable
020	024560	1	Cable Handle Multi-Speed
020	024575	1	Cable Handle Multi-Speed 110V (UK)
020	024580	1	Cable Handle Multi-Speed (NA)
021	960180	1	Clamp Handle Bracket
022	960183	1	Bracket Handle Cross
023	911045	1	Base Twist Lock
024	911046	1	Body Twist Lock
025	163867	1	Lead Earth Base Twist Lock
026	163808	1	Grommet
028	165103	1	Label 'Lift Here & At Rear' (Metal)
029	163201	1	Main Frame
030	167804	1	Shield Wall End
031	962084	4	Screw
034	962204	5	Screw
035	163795	1	Guard Drum Assembly (Grey)
036	121252	1	Label Guard Drum
039	024535	1	Cable Main Assembly Multi-Speed 240V (UK)
039	024540	1	Cable Main Assembly Multi-Speed 240V (AUS)
039	024545	1	Cable Main Assembly Multi-Speed 220Vt (EEC)
039	024550	1	Cable Main Assembly Multi-Speed 110V (UK)
039	024555	1	Cable Main Assembly Multi-Speed 110V (NA)
043	010200	4	Washer
045	920148	1	Nut
046	024600	1	Buffer Rubber
047	980197	1	Washer
048	024605	1	Bolt
049	030850	2	Nut
050	167308	1	Ring Retaining
051	160815	1	Bracket Handle
052	980196	1	Washer
053	962244	5	Bolt

Ref	PSTK	Pack Qty	Description
054	163796	1	Bag Dust Cloth
055	163826	6	Retainer Dust Bag Disposable
056	160809	1	Bracket Exhaust
057	163403	1	Gasket Exhaust
058	07037	25	Disposable Paper Dust Bag HT8 Pack 2
058	07039	50	Disposable Paper Dust Bag HT8
059	163790	1	Tube Exhaust (Grey)
060	167708	1	Shaft Floor Roller
061	169704	2	Roller Floor Assembly (with bearing)
062	902567	4	Bearing (Fan & Floor Roller)
063	467308	4	Ring Retaining
064	020010	1	Support Floor Roller
065	962139	2	Bolt
066	980646	2	Washer
067	962103	1	Screw
072	167902	1	Shoe Intake
073	163636	1	Cover Inlet
074	167404	1	Rod Drum Guard
075	920256	1	Nut
077	980629	1	Washer
078	169504	1	Weight Balance
079	962409	1	Screw
080	962170	1	Screw
081	163791	1	Guard Belt (Grey)
082	163814	3	Screw
083	163869	4	Screw Guard Belt
084	163792	1	Guard Wall End (Grey)
085	980623	2	Washer
086	962109	8	Screw
087	167312	1	Ring Retaining
088	164202	1	Housing Fan
089	168203	1	Spacer Fan Bearing
091	008212	1	Spacer Fan
092	163004	1	Fan Intake
093	162021	2	Clamp Bearing
094	167608	1	Seal fan
095	167210	1	Retainer Seal
096	010210	4	Screw
097	166906	2	Pulley Fan
098	915028	6	Key
099	167704	1	Shaft Fan
100	010220	4	Screw and Washer Set
101	980648	2	Washer
102	980626	3	Washer Lock
103	920132	3	Nut
104	010180	4	Brush Motor
109	010230	4	Brush Spring
110	911662	1	Lead Motor Assembly
111	167302	1	Ring Retaining
113	168104	1	Sleeve
114	163104	1	Field 110/120V HT8
114	163112	1	Field 220/240V HT8
115	962401	2	Screw
116	166172	1	Baffle Motor
117	167204	1	Retainer Baffle
118	160408	1	Armature 110/120V
118	160412	1	Armature 220/240V
119	980004	2	Spacer
121	163008	1	Fan Motor
123	167802	1	Shield Pulley
124	902550	2	Bearing Drum Shaft
125	163682	2	Bearing Armature
126	062003	2	Clamp Bearing
127	962345	10	Screw
128	168212	1	Spacer Motor Pulley
129	163304	3	Flange Pulley
130	166909	1	Pulley Motor
140	163789	1	Brush Block Assembly
142	962411	1	Screw

Ref	PSTK	Pack Qty	Description
143	162006	1	Clamp Bearing
144	925113	1	Pin Drum Shaft
145	161108	1	Bush Bearing
146	168206	1	Spacer Bearing
149	167716	1	Shaft Drum
152	168209	1	Spacer Bearing
159	166916	1	Pulley Drum
164	903260	1	Belt Drum 3/4" (19mm) Wide
165	903273	1	Belt Fan 1/2" (13mm) Wide
167	162312	1	Drum Cover Kit
168	162532	1	Drum Assembly Complete
169	100327	13	Screw
170	163012	1	Assembly Fan Intake
173	163668	1	Lifting Pin Assembly
174	000920	2	Screw Clamp Bar (screwdriver slot)

Ref	PSTK	Pack Qty	Description
174	163657	2	Screw Clamp Bar (coin slot)
175	020045	1	Clamp Bar Paper (reversible)
176	164607	3	Insert Drum Kit
179	024800	1	Owners Manual & Operating Instructions
200	101219	1	Floor Roller Assembly
201	163827	1	Kit Moulded Guards (Grey)
201	163873	1	Kit Moulded Guards (Grey, excl. Tube Exhaust)

Following parts not illustrated

250	024500	1	Test Lead
250	024502	1	Test Lead (NA)
250	011860	2	Service Tool - Extractor Seal
250	100325	1	Service Tool - Clamp Drum Cover
250	163822	1	Service Tool - Drum Insert Removal
250	163857	1	Service Tool - Adjuster Floor Roller
250	163865	1	Service Tool - Locking Drum

CIRCUIT DIAGRAM

HT8-1.2 Floor Sander Multi-Speed

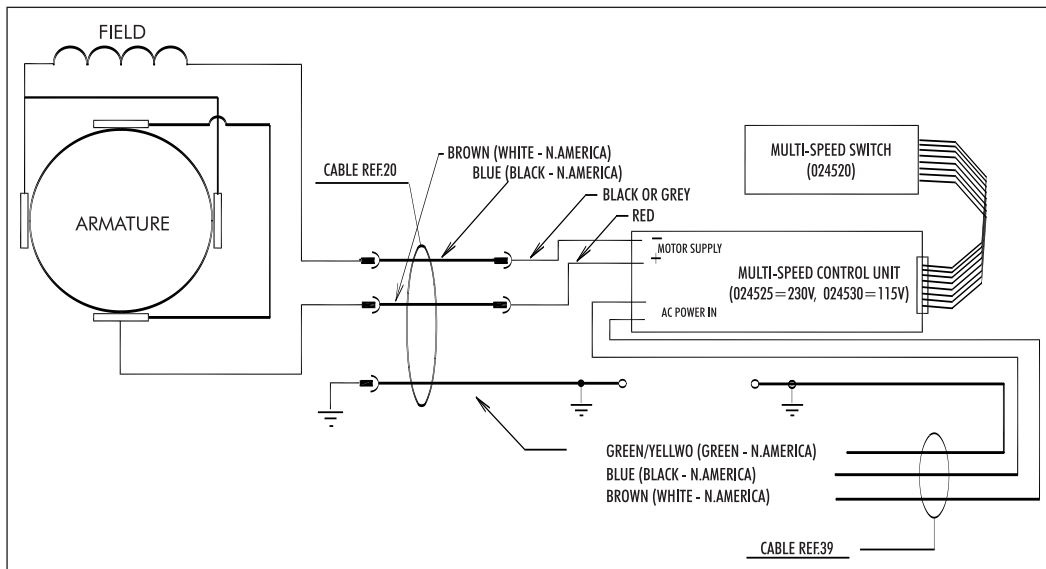

MULTI-SPEED CABLE ROUTING

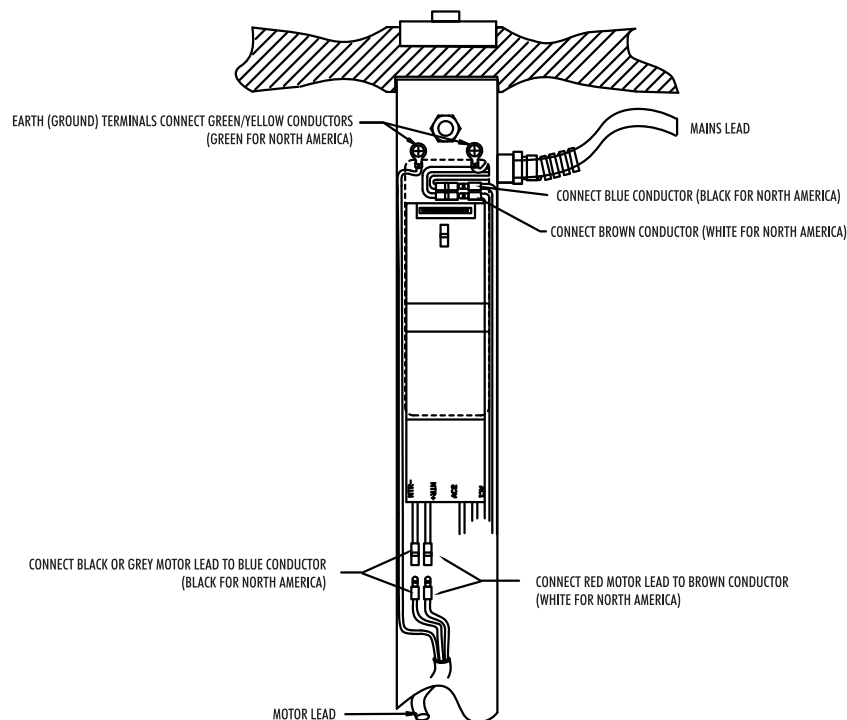

DECLARATION OF CONFORMITY



Manufacturer's Name: Hire Technicians Group Ltd.

Manufacturer's Address: Manufactured by Hiretech in the United Kingdom. See www.hiretech.biz for contact information and address.

declares that the product:

Product Name: Hiretech Floor Sander

Model Name: HT8 230 Volt 50Hz Insulation Class 1
HT8 110 Volt 50Hz Insulation Class 1

conforms to the following:

Machinery Directive (Harmonised) 89/392-EU as amended
Low Voltage Directive (Harmonised) 73/23/EU as amended
Electromagnetic Compatibility Directive 89/336/EU as amended

following the provisions of the directives:

89/392/EU, 93/44EU, 73/23/EU, 93/68/EU/89/336/EU, 91/368/EU, 92/31/EU
EN60 335-1-88 (HD 251-1-3) BS 3456-201 EN292-1-91
EN292-2-91 EN60204-1-92
EN55014-93 (BS 800) EN 50082-1-92
IEC 745-2-4 (HD 400.2) (BS 2769-2-2.4)

electrical safety test procedures comply with:

IEC 335 pt. 1-2, HD251 1-3 1982, BS 2769 & 3456, CSA C22-2,
KEMA K78A1/W1 & W3, NEMKO 503./89, DIN VDE 0700 1/04.88
HD 264.S2 15/07.86

Where the product is licensed to carry a National Approval Mark it is certified that all such products comply with the terms of that license.

C.J. Hedger, Director of Engineering. 1 April 2012

HIRETECH LIMITED WARRANTY

Hiretech warrants to the original purchaser that the Hiretech machine covered by this warranty is free from defects in workmanship and materials. Should any part fail in the period of two years from the date of the original purchase as a result of a defect, Hiretech will (at its option) either repair or replace the part without charge provided that the machine has been operated in accordance with the Owners Manual and Operating Instructions.

Should any such defect arise, please contact your nearest authorised repair agent. Standard service over land mainland freight costs will be refunded on warranty repairs at the sole discretion of Hiretech or the authorised repair agent. If the repair is non-warranty, the customer will be advised before any work is undertaken.

This warranty is the sole warranty by Hiretech and is in lieu of all other warranties express or implied and releases Hiretech from all other obligations and liabilities.

This warranty does not apply to normal wear and tear to the machine, and in particular does not cover normal wear parts such as mains cable, wheels, switches, relays, brushes, rubber parts, hoses and bearings. This warranty also does not cover, and Hiretech will not be liable for, excessive wear caused by abnormal use.

Hiretech will under no circumstances be liable for alterations to the machine or for damage caused by third persons, or for misuse or abuse of the machine, or damage caused during transportation. Repairs of the machine made or attempted by persons other than those specifically authorised by Hiretech shall render this warranty void and Hiretech will not be liable for such repairs, the cost of such repairs, or the consequences of such repairs. Where spare parts are used on the machine and they do not conform to Hiretech specifications, this warranty will be rendered void and Hiretech will not be liable.

Hiretech will not be liable for any indirect or consequential loss, damage, cost or expense of any kind whatever and however caused whether arising under contract, tort (including negligence) or otherwise including (without limitation) loss of production, loss of profits or contracts or of operating time or goodwill or anticipated savings.

Every effort has been made to present all information in this publication accurately, however no liability is accepted for any inclusions or advice given or for omissions from this publication. Hiretech reserves the right to make changes or improvements to its products without prior notice. Hiretech® is a registered trademark of Hire Technicians Group Ltd., all other trademarks are the property of their respective owners.
© Hire Technicians Group Ltd.

MANUFACTURED BY

HIRE TECHNICIANS GROUP LIMITED
TEL: +44 (0)1923 332424 FAX: +44 (0)1923 332425
E-mail: sales@hiretech.biz Web: www.hiretech.biz

